

Features

- Dual 15-A Outputs
(Independently Regulated)
- Power-up/Down Sequencing
- Input Voltage Range:
36 V to 75 V
- 1500 VDC Isolation
- Temp Range: -40 to 100 °C
- High Efficiency: 88 %
- Fixed Frequency Operation
- Over-Current Protection
(Both Outputs)
- Dual Logic On/Off Control
- Over-Temperature Shutdown
- Over-Voltage Protection
(Coordinated Shutdown)
- Under-Voltage Lockout
- Input Differential EMI Filter
- IPC Lead Free 2
- Safety Approvals:
UL1950
CSA 22.2 950

Description

The PT4660 Excalibur™ Series is a 30-A rated, dual-output isolated DC/DC converter that combines state-of-the-art power conversion technology with unparalleled flexibility. These modules operate from a standard telecom (-48 V) central office (CO) supply to produce two independently regulated outputs.

The PT4660 series is characterized with high efficiencies and ultra-fast transient response, and incorporates many features to facilitate system integration. These include a flexible “On/Off” enable control, output current limit, over-temperature

protection, and an input under-voltage lockout (UVLO). In addition, both output voltages are designed to meet the power-up/power-down sequencing requirements of popular DSPs.

The PT4660 series is housed in space-saving solderable copper case. The package does not require a heatsink and is available in both vertical and horizontal configurations, including surface mount. The ‘N’ configuration occupies less than 2 in² of PCB area.

Ordering Information

Pt. No.	Vo ₁ /Vo ₂
PT4661□	= 5.0/3.3 Volts
PT4662□	= 3.3/2.5 Volts
PT4663□	= 3.3/1.8 Volts
PT4665□	= 3.3/1.5 Volts
PT4666□	= 2.5/1.8 Volts
PT4667□	= 5.0/1.8 Volts
PT4668□	= 3.3/1.2 Volts

PT Series Suffix (PT1234 x)

Case/Pin Configuration	Order Suffix	Package Code
Vertical	N	(EKD)
Horizontal	A	(EKA)
SMD	C	(EKC)

(Reference the applicable package code drawing for the dimensions and PC board layout)

Typical Application

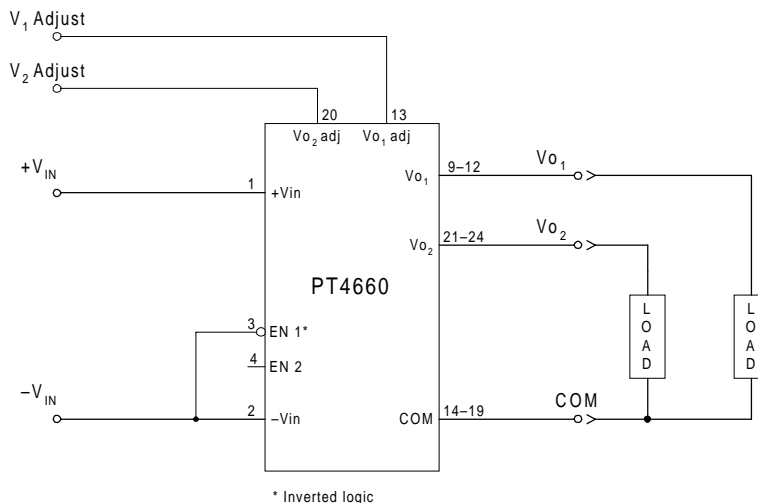

Pin-Out Information

Pin	Function	Pin	Function	Pin	Function
1	+V _{in}	10	+Vo ₁	19	COM
2	-V _{in}	11	+Vo ₁	20	Vo ₂ Adjust
3	EN 1	12	+Vo ₁	21	+Vo ₂
4	EN 2	13	Vo ₁ Adjust	22	+Vo ₂
5	TEMP	14	COM	23	+Vo ₂
6	AUX	15	COM	24	+Vo ₂
7	Do Not Connect	16	COM	25	Do Not Connect
8	Do Not Connect	17	COM	26	Do Not Connect
9	+Vo ₁	18	COM		

Note: Shaded functions indicate signals that are referenced to the input (-V_{in}) potential.

On/Off Logic

Pin 3	Pin 4	Output Status
1	×	Off
0	1	On
×	0	Off

Notes:

Logic 1 = Open collector

Logic 0 = -V_{in} (pin 2) potential

For positive Enable function, connect pin 3 to pin 2 and use pin 4.

For negative Enable function, leave pin 4 open and use pin 3.

Pin Descriptions

+V_{in}: The positive input supply for the module with respect to -V_{in}. When powering the module from a -48 V telecom central office supply, this input is connected to the primary system ground.

-V_{in}: The negative input supply for the module, and the 0 VDC reference for the EN 1, EN 2, TEMP, and AUX signals. When the module is powered from a +48-V supply, this input is connected to the 48-V Return.

EN 1: This an open-collector (open-drain) negative logic input that enables the module output. This pin is TTL compatible and referenced to -V_{in}. A logic '0' at this pin enables the module's outputs, and a logic '1' or high impedance disables the module's outputs. If not used, the pin must be connected to -V_{in}.

EN 2: An open-collector (open-drain) positive logic input that enables the module output. This pin is TTL compatible and referenced to -V_{in}. A logic '1' or high impedance enables the module's outputs. If not used, the pin should be left open circuit.

AUX: Produces a regulated output voltage of 11.6 V ±5 %, which is referenced to -V_{in}. The current drawn from the pin must be limited to 10mA. The voltage may be used to indicate the output status of the module to a primary referenced circuit, or power a low-current amplifier.

TEMP: This is the output voltage produced by the module's internal temperature sensor. The voltage at this pin is referenced to -V_{in} and rises approximately 10 mV/°C from an initial value of 0.1 VDC at -40 °C.

$$V_{\text{temp}} = 0.5 + 0.01 \cdot T_{\text{sense}}$$

The signal is available whenever the module is supplied with a valid input voltage, and is independent of the enable logic status. (Note: A load impedance of less than 1 MΩ will adversely affect the module's over-temperature shutdown threshold. Use a high-impedance input when monitoring this signal.)

Vo₁: The higher regulated output voltage, which is referenced to the COM node.

Vo₂: The lower regulated output voltage, which is referenced to the COM node.

COM: The secondary return reference for the module's two regulated output voltages. It is dc isolated from the input supply pins.

Vo₁ Adjust: Using a single resistor, this pin allows V_{o1} to be adjusted higher or lower than the preset value. If not used, this pin should be left open circuit.

Vo₂ Adjust: Using a single resistor, this pin allows V_{o2} to be adjusted higher or lower than the preset value. If not used, this pin should be left open circuit.

Specifications (Unless otherwise stated, $T_a = 25^\circ\text{C}$, $V_{in} = 48\text{ V}$, & $I_{O1} = I_{O2} = 10\text{ A}$)

Characteristics	Symbols	Conditions	PT4660 SERIES			Units	
			Min	Typ	Max		
Output Current	I_{O1}, I_{O2}	V_{O1}	$V_{O1} \leq 3.3\text{ V}$ $V_{O1} = 5.0\text{ V}$	0 0	— —	15 10	A
		V_{O2}	All voltages	0	—	15	A
	$I_{O1} + I_{O2}$	Total (both outputs)	$V_{O1} \leq 3.3\text{ V}$ $V_{O1} = 5.0\text{ V}$	0 0	— —	30 25	A
Input Voltage Range	V_{in}		36	48	75	V	
Set Point Voltage Tolerance	$V_o\text{tol}$		—	± 1	± 2	% V_o	
Temperature Variation	$\Delta\text{Reg}_{\text{temp}}$	-40 to +100 °C Case, $I_{O1} = I_{O2} = 0\text{ A}$	—	± 0.5	—	% V_o	
Line Regulation	$\Delta\text{Reg}_{\text{line}}$	Over V_{in} range with $I_{O1} = I_{O2} = 5\text{ A}$	—	± 5	± 10	mV	
Load Regulation	$\Delta\text{Reg}_{\text{load}}$	1 A $\leq I_{O1} \leq I_{O1\text{max}}$, $I_{O2} = 1\text{ A}$	ΔV_{O1}	—	± 2	± 10	mV
		1 A $\leq I_{O2} \leq I_{O2\text{max}}$, $I_{O1} = 1\text{ A}$	ΔV_{O2}	—	± 2	± 10	
Cross Regulation	$\Delta\text{Reg}_{\text{cross}}$	1 A $\leq I_{O2} \leq I_{O2\text{max}}$, $I_{O1} = 1\text{ A}$	ΔV_{O1}	—	± 2	± 10	mV
		1 A $\leq I_{O1} \leq I_{O1\text{max}}$, $I_{O2} = 1\text{ A}$	ΔV_{O2}	—	± 2	± 5	
Total Output Variation	$\Delta V_{o\text{tol}}$	Includes set-point, line load, -40 °C to +100 °C case	ΔV_{O1} ΔV_{O2}	— —	± 2 ± 2	± 3 ± 3	% V_o
Efficiency	η		PT4661	—	88	—	%
			PT4662	—	87	—	
			PT4663	—	86	—	
			PT4665	—	86	—	
			PT4666	—	85	—	
			PT4667	—	88	—	
			PT4668	—	86	—	
V_o Ripple (pk-pk)	V_r	$I_{O1} = I_{O2} = 5\text{ A}$, 20 MHz bandwidth	$V_o = 5\text{ V}$ $V_o < 5\text{ V}$	— —	— —	75 50	mV _{pp}
Transient Response	t_{tr}	1 A/ μs load step from 50 % to 100 % $I_{O\text{max}}$ (either output)	—	25 6.0	100 —	μSec % V_o	
Current Limit	I_{LIM}	Each output with other unloaded	15.5	18	—	A	
Output Rise Time	t_{on}	At turn-on to within 90 % of V_o	—	5	10	mSec	
Output Over-Voltage Protection	OVP	Either output; shutdown and latch off	—	125 (1)	—	% V_o	
Output Voltage Adjustment	$\Delta V_{o\text{adj}}$	V_{O1}, V_{O2}	—	± 10	—	% V_o	
Switching Frequency	f_s		270	—	330	kHz	
Under-Voltage-Lockout	UVLO	Rising	—	34	36	V	
		Falling	30	32	—		
Internal Input Capacitance	C_{in}		—	2	—	μF	
Enable Control Inputs		Referenced to $-V_{in}$					
Input High Voltage	V_{IH}		3.5	—	—	V	
Input Low Voltage	V_{IL}		0	—	0.8 (2)	V	
Input Low Current	I_{IL}		—	0.5	—	mA	
Standby Current	$I_{in\text{ standby}}$	Pins 2, 3, & 4 connected	—	3	5	mA	
External Output Capacitance	C_{out}	Per each output	0	—	5,000	μF	
Primary/Secondary Isolation	V_{iso}		1500	—	—	V	
	C_{iso}		—	1500	—	pF	
	R_{iso}		10	—	—	M Ω	
Temperature Sense	V_{temp}	Output voltage at temperatures:-	-40 °C	—	0.1 (3)	—	V
			100 °C	—	1.5 (3)	—	
Operating Temperature Range	T_a	Over V_{in} range	-40	—	85 (4)	°C	
Over-Temperature Protection	OTP	Case temperature (auto restart)	100	—	—	°C	
Solder Reflow Temperature	T_{reflow}	Surface temperature of module pins or case	—	—	215 (5)	°C	
Storage Temperature	T_s	—	-40	—	125	°C	
Mechanical Shock	—	Per Mil-STD-883D, Method 2002.3	—	500	—	G's	
Mechanical Vibration	—	Per Mil-STD-883D, Method 2007.2, Suffixes A, C	Suffix N	—	10 (6)	—	G's
			Suffixes A, C	—	20 (6)	—	
Weight	—	—	—	90	—	grams	
Flammability	—	Materials meet UL 94V-0	—	—	—	—	

- Notes:** (1) This is a fixed parameter. Adjusting V_{O1} or V_{O2} higher will increase the module's sensitivity to over-voltage detection. For more information, see the application note on output voltage adjustment.
- (2) The EN_1 and EN_2 control inputs (pins 3 & 4) have internal pull-ups and may be controlled with an open-collector (or open-drain) transistor. Both inputs are diode protected and can be connected to $+V_{in}$. The maximum open-circuit voltage is 5.4 V.
- (3) Voltage output at "TEMP" pin is defined by the equation: $V_{TEMP} = 0.5 + 0.01 \cdot T$, where T is in °C. See pin descriptions for more information.
- (4) See SOA curves or consult the factory for the appropriate derating.
- (5) During solder reflow of SMD package version do not elevate the module case, pins, or internal component temperatures above a peak of 215 °C. For further guidance refer to the application note, "Reflow Soldering Requirements for Plug-in Power Surface Mount Products," (SLTA051).
- (6) The case pins on the through-hole package types (suffixes N & A) must be soldered. For more information see the applicable package outline drawing.

PT4661 ($V_1/V_2 = 5.0V/3.3V$); $V_{in} = 48V$ (See Notes A & B)

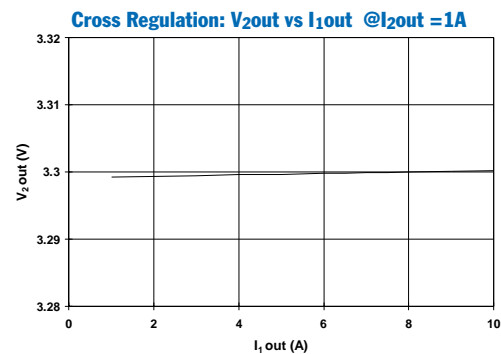
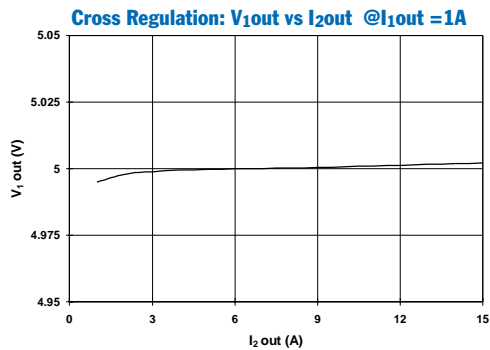
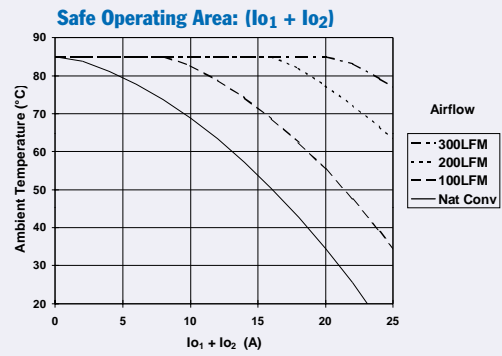
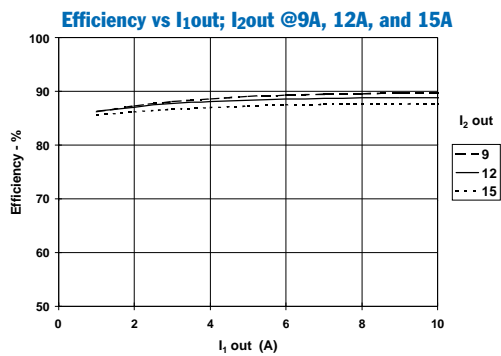
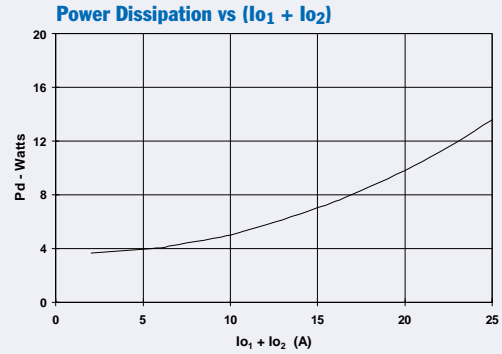
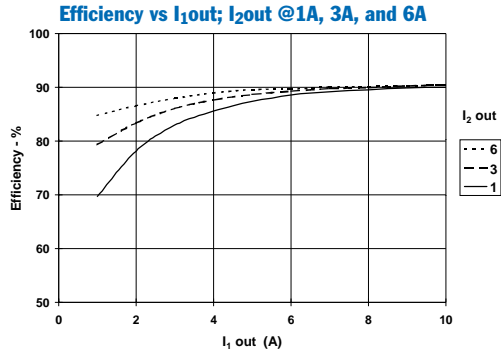

Note A: All Characteristic data in the above graphs has been developed from actual products tested at 25°C. This data is considered typical data for the converter.
Note B: SOA curves represent operating conditions at which internal components are at or below manufacturer's maximum rated operating temperatures.

PT4662 ($V_1/V_2 = 3.3 \text{ V}/2.5 \text{ V}$); $V_{in} = 48 \text{ V}$ (See Notes A & B)

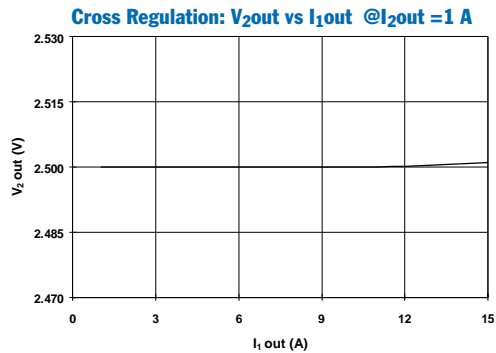
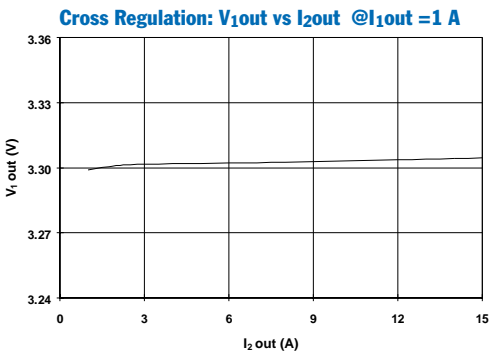
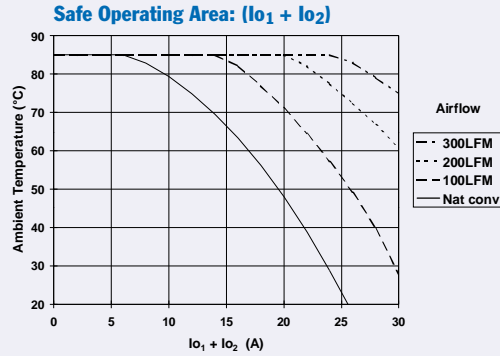
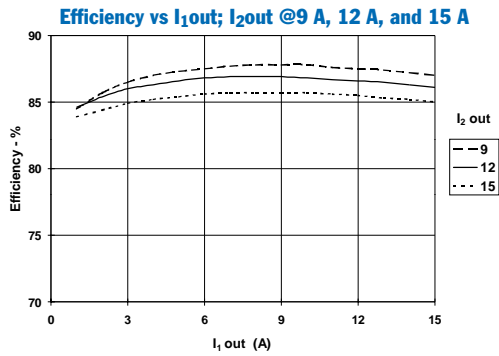
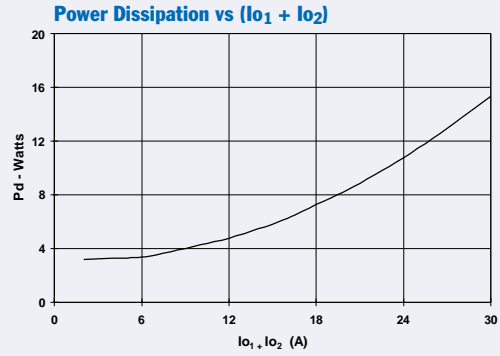
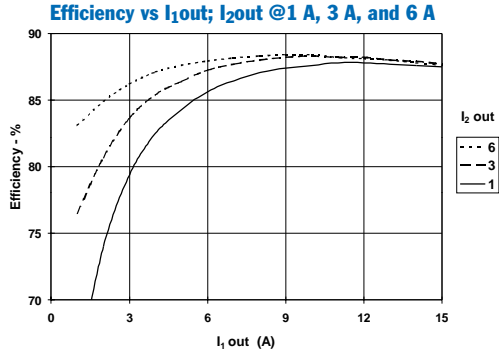

Note A: All Characteristic data in the above graphs has been developed from actual products tested at 25 °C. This data is considered typical data for the converter.
Note B: SOA curves represent operating conditions at which internal components are at or below manufacturer's maximum rated operating temperatures.

PT4663 ($V_1/V_2 = 3.3\text{ V}/1.8\text{ V}$); $V_{in} = 48\text{ V}$ (See Notes A & B)

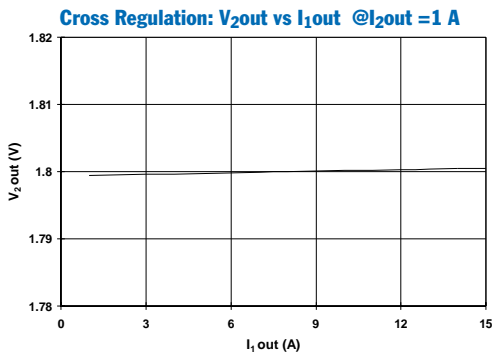
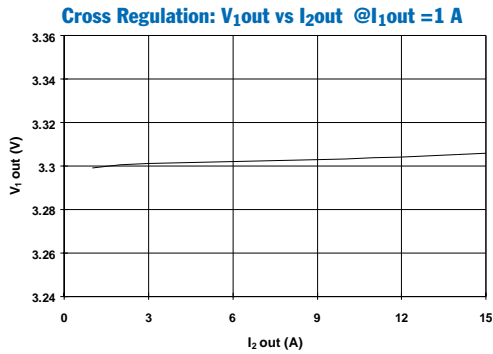
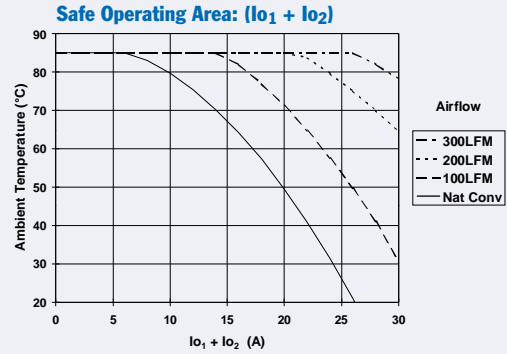
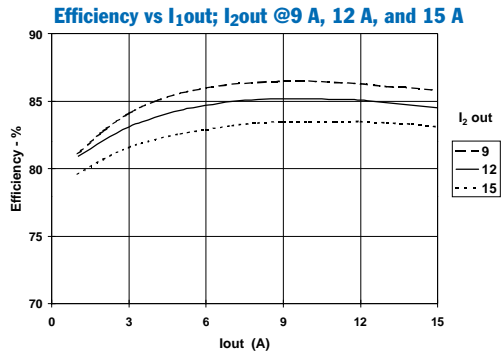
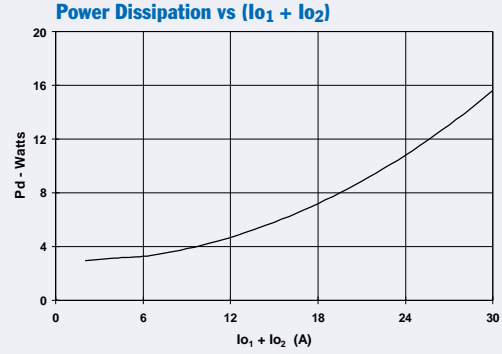
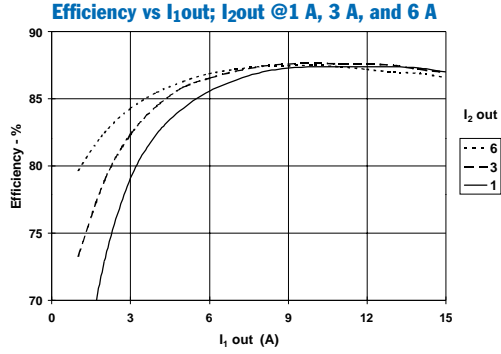

Note A: All Characteristic data in the above graphs has been developed from actual products tested at 25 °C. This data is considered typical data for the converter.
Note B: SOA curves represent operating conditions at which internal components are at or below manufacturer's maximum rated operating temperatures.

PT4665 ($V_1/V_2 = 3.3 \text{ V}/1.5 \text{ V}$); $V_{in} = 48 \text{ V}$ (See Notes A & B)

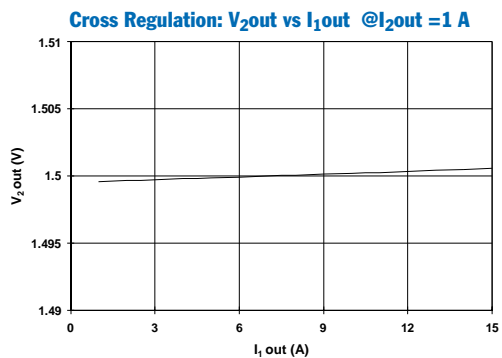
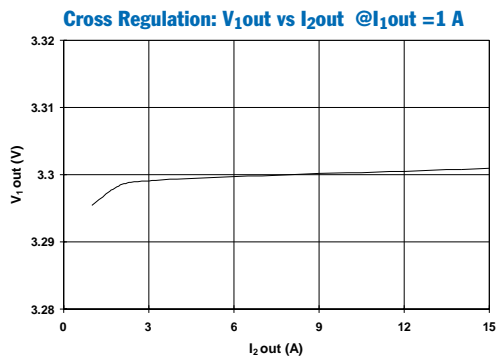
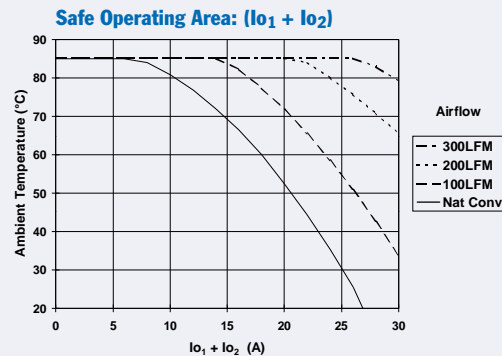
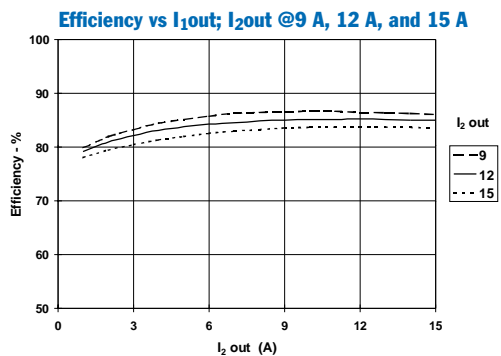
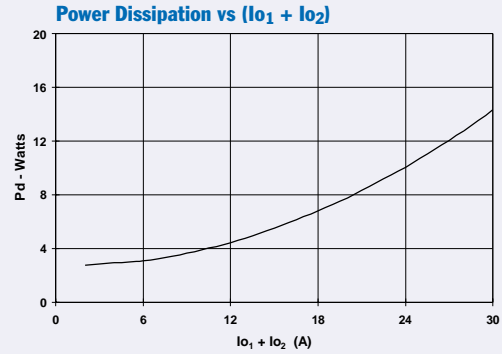
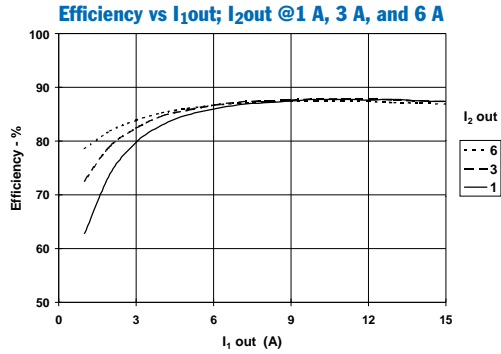

Note A: All Characteristic data in the above graphs has been developed from actual products tested at 25 °C. This data is considered typical data for the converter.
Note B: SOA curves represent operating conditions at which internal components are at or below manufacturer's maximum rated operating temperatures.

PT4666 ($V_1/V_2 = 2.5 V/1.8 V$); $V_{in} = 48 V$ (See Notes A & B)

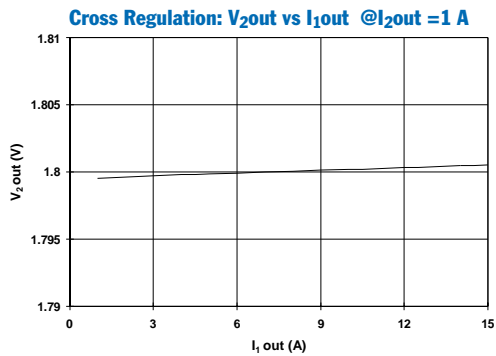
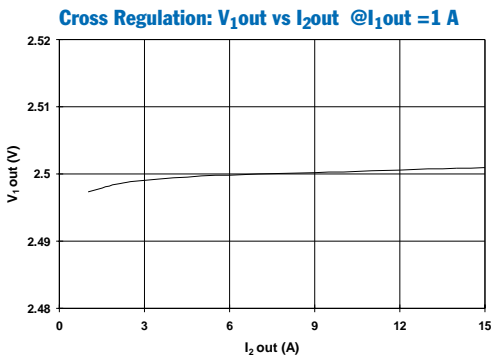
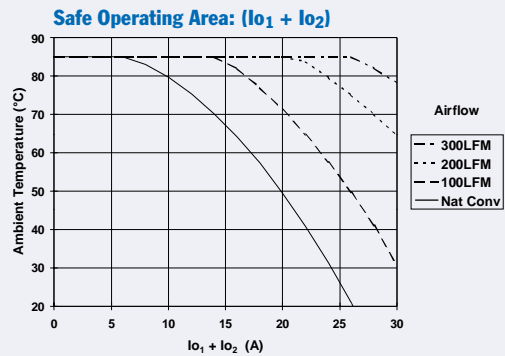
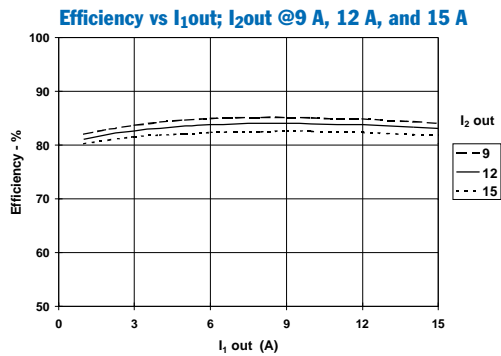
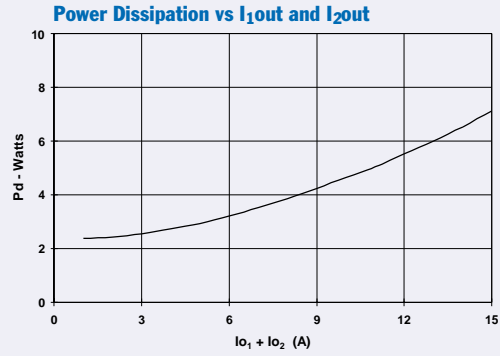
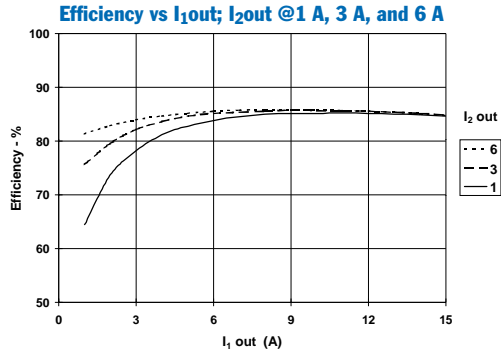

Note A: All Characteristic data in the above graphs has been developed from actual products tested at 25 °C. This data is considered typical data for the converter.
Note B: SOA curves represent operating conditions at which internal components are at or below manufacturer's maximum rated operating temperatures.

PT4667 ($V_1/V_2 = 5 V/1.8 V$); $V_{in} = 48 V$ (See Notes A & B)

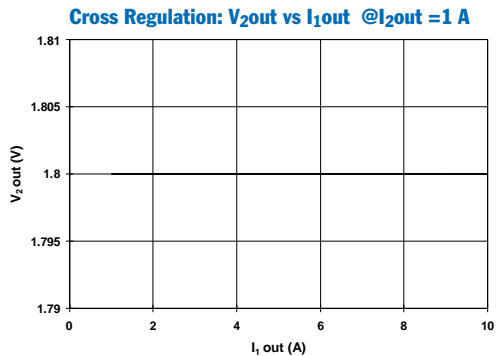
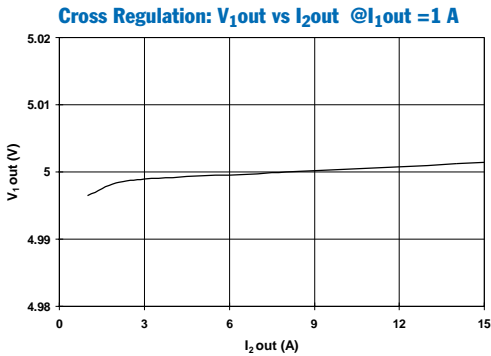
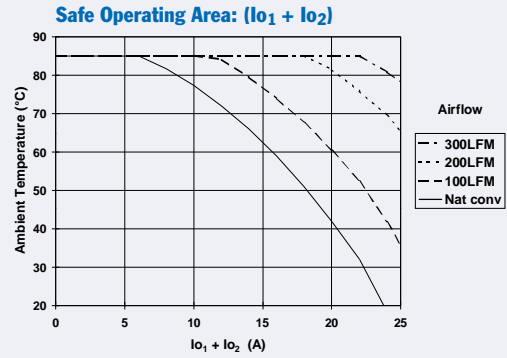
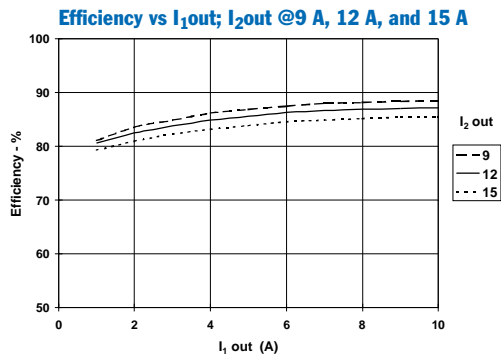
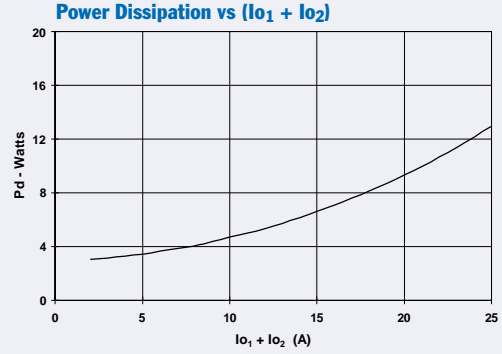
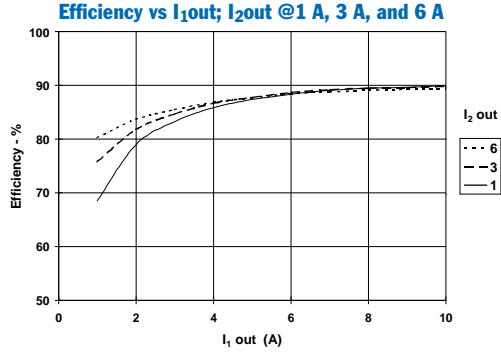

Note A: All Characteristic data in the above graphs has been developed from actual products tested at 25 °C. This data is considered typical data for the converter.
Note B: SOA curves represent operating conditions at which internal components are at or below manufacturer's maximum rated operating temperatures.

PT4668 ($V_1/V_2 = 3.3\text{ V}/1.2\text{ V}$); $V_{in} = 48\text{ V}$ (See Notes A & B)

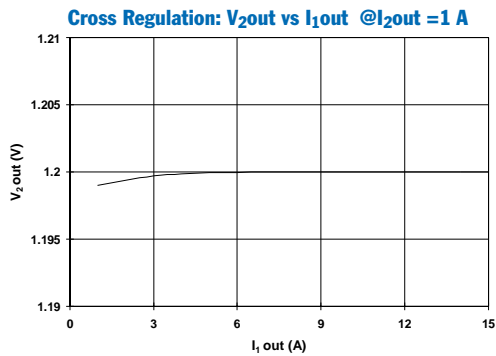
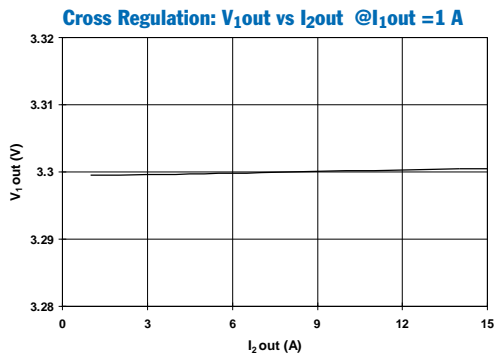
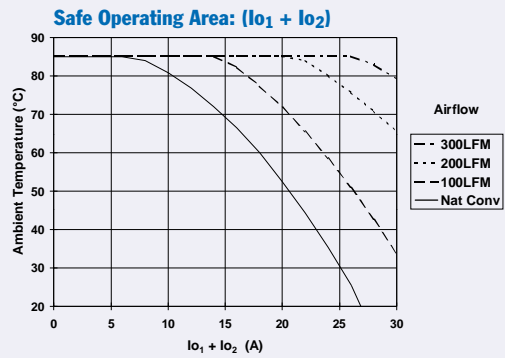
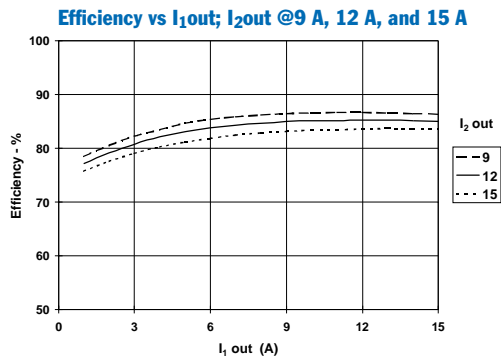
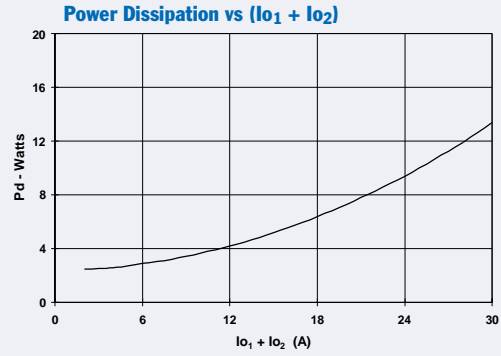
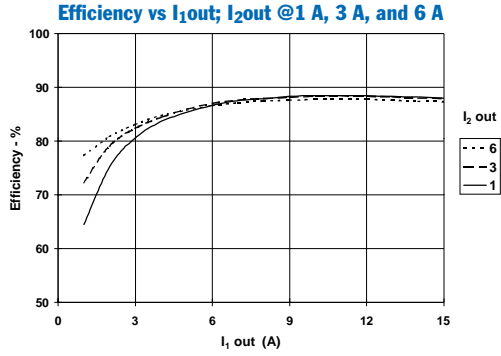

Note A: All Characteristic data in the above graphs has been developed from actual products tested at 25 °C. This data is considered typical data for the converter.
Note B: SOA curves represent operating conditions at which internal components are at or below manufacturer's maximum rated operating temperatures.

Operating Features & System Considerations for the PT4660 & PT4680 Dual-Output Converters

Over-Current Protection

The dual-outputs of the PT4660 and PT4680 series of DC/DC converters have independent output voltage regulation and current limit control. Applying a load current in excess of the current limit threshold at either output will cause the respective output voltage to drop. However, the voltage at V_{O2} is derived from V_{O1} . Therefore a current limit fault on V_{O1} will also cause V_{O2} to drop. Conversely, a current limit fault applied to V_{O2} will only cause V_{O2} voltage to drop, and V_{O1} will remain in regulation.

The current limit is continuous with some current fold-back. This means that at short circuit, the value of the output current can be less than the rated output of the converter. This is to reduce power dissipation when a fault is present. As with any foldback-limited source, if a constant current load is applied to the converter with a value greater than the short-circuit current, the output voltage will not come up. Resistive and non-linear load circuits are not affected by this characteristic as long as the current at startup does not exceed the short-circuit current of the converter. The majority of low-voltage analog and digital applications are not affected by this restriction. However, when testing with an electronic load the constant resistance setting should be used.

Output Over-Voltage Protection

Each output is monitored for over voltage (OV). For fail safe operation and redundancy, the OV fault detection circuitry uses a separate reference to the voltage regulation circuits. The OV threshold is fixed, and set nominally 25 % higher than the set-point output voltage. If either output exceeds the threshold, the converter is shutdown and must be actively reset. The OV protection circuit can be reset by momentarily turning the converter off. This is accomplished by either cycling one of the output enable control pins ($EN1$ or $EN2$), or by removing the input power to the converter. *Note: If V_{O1} or V_{O2} is adjusted to a higher voltage, the margin between the respective steady-state output voltage and its OV threshold is reduced. This can make the module sensitive to OV fault detection, that may result from random noise and load transients.*

Over-Temperature Protection

The converter has an internal temperature sensor. At a case temperature of approximately 115 °C the converter will shut down, and will automatically restart when the temperature returns to about 100 °C. The analog voltage generated by the sensor is also made available at the $TEMP$ output (pin 5), and can be monitored by the

host system for diagnostic purposes. Consult the 'Pin Descriptions' section of the data sheet for further information on this feature.

Under-Voltage Lock-Out

The Under-Voltage Lock-Out (UVLO) circuit prevents operation of the converter whenever the input voltage to the module is insufficient to maintain output regulation. The UVLO has approximately 2 V of hysteresis. This is to prevent oscillation with a slowly changing input voltage. Below the UVLO threshold the module is off and the enable control inputs, $EN1$ and $EN2$ are inoperative.

Primary-Secondary Isolation

The PT4660 and PT4680 series of DC/DC converters incorporate electrical isolation between the input terminals (primary) and the output terminals (secondary). All converters are production tested to a withstand voltage of 1500 VDC. The isolation complies with UL60950 and EN60950, and the requirements for operational isolation. This allows the converter to be configured for either a positive or negative input voltage source.

The regulation control circuitry for these modules is located on the secondary (output) side of the isolation barrier. Control signals are passed between the primary and secondary sides of the converter via a proprietary magnetic coupling scheme. This eliminates the use of opto-couplers. The data sheet 'Pin Descriptions' and 'Pin-Out Information' provides guidance as to which reference (primary or secondary) that must be used for each of the external control signals.

Fuse Requirements

To comply with safety agency requirements, these converters **must** be operated with an external input fuse. A fast-acting 250-V fuse is required. Table 1-1 gives the recommended current rating for the product series being used.

Table 1-1; Recommended Fuse Rating

Product Series	Input Bus	Total Iout	Fuse Rating
PT4660	48 V	30 A	7 A
PT4680	24 V	20 A	10 A

Using the On/Off Enable Controls on the PT4660 & PT4680 Series of Dual-Output Converters

The PT4660 (48V input) and PT4680 (24V input) series of dual-output DC/DC converters incorporate both positive and negative logic output enable controls. *EN1* (pin 3) is the negative enable input, and *EN2* (pin 4) is the positive enable input. Both inputs are TTL logic compatible, and are electrically referenced to $-V_{in}$ (pin 2) on the primary (input) side of the converter. A pull-up resistor is not required, but may be added if desired. Adding a pull-up resistor from either *EN1* or *EN2*, up to $+V_{in}$, will not damage the converter.

Automatic (UVLO) Power-Up

Connecting *EN1* (pin 3) to $-V_{in}$ (pin 2) and leaving *EN2* (pin 4) open-circuit configures the converter for automatic power up. (See data sheet “Typical Application”). The converter control circuitry incorporates an “Under Voltage Lockout” (UVLO) function, which disables the output until the minimum specified input voltage is present (See data sheet Specifications). The UVLO circuitry ensures a clean transition during power-up and power-down, allowing the converter to tolerate a slow-rising input voltage. For most applications *EN1* and *EN2*, can be configured for automatic power-up.

Positive Output Enable (Negative Inhibit)

To configure the converter for a positive enable function, connect *EN1* (pin 3) to $-V_{in}$ (pin 2), and apply the system On/Off control signal to *EN2* (pin 4). In this configuration, a logic ‘0’ ($-V_{in}$ potential) applied to pin 4 disables the converter outputs. An example of this configuration is detailed in Figure 2-1.

Figure 2-1; Positive Enable Configuration

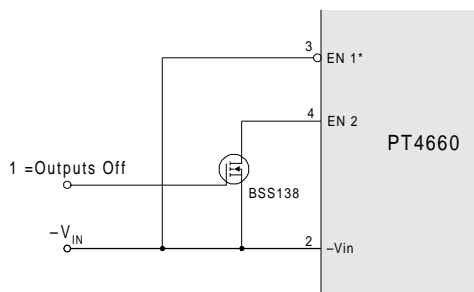

Negative Output Enable (Positive Inhibit)

To configure the converter for a negative enable function, *EN2* (pin 4) is left open circuit, and the system On/Off control signal is applied to *EN1* (pin 3). A logic ‘0’ ($-V_{in}$ potential) must then be applied to pin 3 in order to enable

the outputs of the converter. An example of this configuration is detailed in Figure 2-2. *Note: The converter will only produce and output voltage if a valid input voltage is applied to $\pm V_{in}$.*

Figure 2-2; Negative Enable Configuration

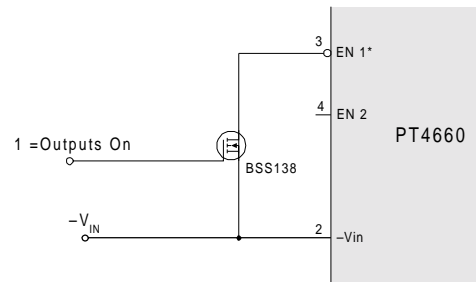

On/Off Output Voltage Sequencing

The output voltages from these dual-output DC/DC converters are independently regulated, and are internally sequenced to meet the power-up requirements of popular microprocessor and DSP chipsets. Figure 2-3 shows the waveforms from a PT4661 after the converter is enabled at $t=0$ s. During power-up, the V_{O1} and V_{O2} voltage waveforms typically track within 0.4V prior to V_{O2} reaching regulation. The waveforms were measured with a 5- A_{dc} resistive load at each output, and with a 48-VDC input source applied. The converter typically produces a fully regulated output within 25ms. The actual turn-on time will vary slightly with input voltage, but the power-up sequence is independent of the load at either output.

Figure 2-3; V_{O1} , V_{O2} Power-Up Sequence

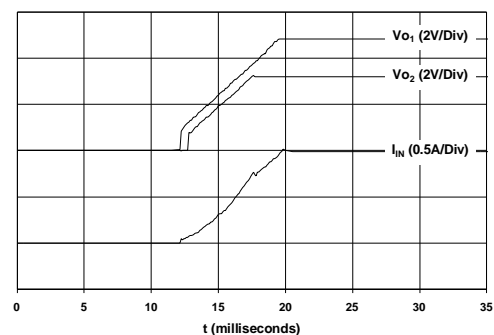

During turn-off, both outputs drop rapidly due to the discharging effect of actively switched rectifiers. The voltage at V_{O1} remains higher than V_{O2} during this period. The discharge time is typically 100 μ s, but will vary with the amount of external load capacitance.

Adjusting the Output Voltage of the PT4660 & PT4680 Series of Dual-Output Converters

The dual output voltages from the PT4660 (48-V Bus), and PT4680 (24-V Bus) series of DC/DC converters can be independently adjusted by up to 10 %, higher or lower than the factory trimmed pre-set voltage. The adjustment method requires the addition of a single external resistor ¹. Table 3-1 gives the adjustment range of V_{O1} and V_{O2} for each model in the series as $V_a(\text{min})$ and $V_a(\text{max})$.

V_{O1} Adjust Down: Add a resistor (R_1), between pin 13 ($V_{O1} \text{ Adj}$) and pin 12 (V_{O1}) ².

V_{O1} Adjust Up: To increase the output, add a resistor R_2 between pin 13 ($V_{O1} \text{ Adj}$) and pin 14 (COM) ^{2, 4}.

V_{O2} Adjust Down: Add a resistor (R_3) between pin 20 ($V_{O2} \text{ Adj}$) and pin 21 (V_{O2}) ².

V_{O2} Adjust Up: Add a resistor R_4 between pin 20 ($V_{O2} \text{ Adj}$) and pin 19 (COM) ^{2, 4}.

Refer to Figure 3-1 and Table 3-2 for both the placement and value of the required resistor.

Notes:

- Adjust resistors are not required if V_{O1} and V_{O2} are to remain at their respective nominal set-point voltage. In this case, $V_{O1} \text{ Adj}$ (pin 13) and $V_{O2} \text{ Adj}$ (pin 20) are left open-circuit
- Use only a single 1% resistor in either the (R_1) or R_2 location to adjust V_{O1} , and in the (R_3) or R_4 location to adjust V_{O2} . Place the resistor as close to the converter as possible.

- V_{O2} must always be at least 0.3 V lower than V_{O1} .
- The over-voltage protection** threshold is fixed, and is set nominally 25 % above the set-point output voltage. Adjusting V_{O1} or V_{O2} higher will reduce the voltage margin between the respective steady-state output voltage and its over-voltage (OV) protection threshold. This could make the module sensitive to OV fault detection, as a result of random noise and load transients.
Note: An OV fault is a latched condition that shuts down both outputs of the converter. The fault can only be cleared by cycling one of the Enable control pins (EN_1^ / EN_2), or by momentarily removing the input power to the module.*
- Never connect capacitors to either the $V_{O1} \text{ Adj}$ or $V_{O2} \text{ Adj}$ pins. Any capacitance added to these control pins will affect the stability of the respective regulated output.

The adjust up and adjust down resistor values can also be calculated using the following formulas. Be sure to select the correct formula parameter from Table 3-1 for the output and model being adjusted.

$$(R_1) \text{ or } (R_3) = \frac{R_o \cdot (V_a - V_r)}{(V_o - V_a)} - R_s \quad \text{k}\Omega$$

$$R_2 \text{ or } R_4 = \frac{R_o \cdot V_r}{V_a - V_o} - R_s \quad \text{k}\Omega$$

Where: V_o = Original output voltage, (V_{O1} or V_{O2})
 V_a = Adjusted output voltage
 V_r = The reference voltage from Table 3-1
 R_o = The resistance constant in Table 3-1
 R_s = The series resistance from Table 3-1

Figure 3-1; Placement of Output Adjust Resistors

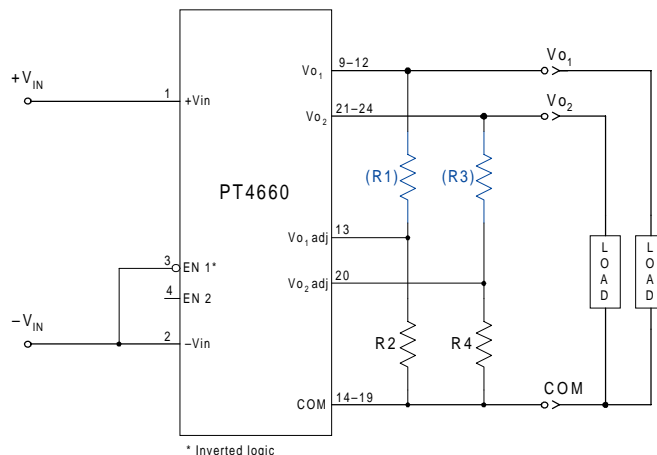

Table 3-1; ADJUSTMENT RANGE AND FORMULA PARAMETERS

Vo ₁ Bus				Vo ₂ Bus (2)					
24 V Bus Pt.#	PT4681/7	PT4682/3/5/8	PT4686	PT4681	PT4682	PT4683/7	PT4686	PT4685	
48 V Bus Pt.#	PT4661/7	PT4662/3/5/8	PT4666	PT4661	PT4662	PT4663/7	PT4666	PT4665	PT4668
Adj. Resistor	(R1)/R2	(R1)/R2	(R1)/R2	(R3)/R4	(R3)/R4	(R3)/R4	(R3)/R4	(R3)/R4	(R3)/R4
V _o (nom)	5.0 V	3.3 V	2.5 V	3.3 V	2.5 V	1.8 V	1.8 V	1.5 V	1.2 V
V _a (min)	4.5 V	2.97 V	2.25 V	2.97 V	2.25 V	1.62 V	1.62 V	1.35 V	1.08 V
V _a (max)	5.5 V	3.63 V	2.75 V	3.63 V	2.75 V	1.98 V	1.98 V	1.65 V	1.32 V
V _r	2.5 V	1.65 V	1.25	1.65 V	1.25 V	0.9 V	0.9 V	0.75 V	0.6V
R _o (kΩ)	4.99	4.99	4.99	1.21	1.21	1.21	1.21	1.21	1.21
R _s (kΩ)	20.0	20.0	20.0	4.99	4.99	4.99	3.32	4.99	3.32

Table 3-2a; ADJUSTMENT RESISTOR VALUES, Vo₁

24 V Bus Pt.#	PT4681/7	PT4682/3/5		PT4686
48 V Bus Pt.#	PT4661/7	PT4662/3/5/8		PT4666
Adj. Resistor	(R1)/R2	(R1)/R2		(R1)/R2
V _o (nom)	5.0 V	3.3 V		2.5 V
V _a (req'd)	V _a (req'd)		V _a (req'd)	
5.5	5.0 kΩ	3.6	7.4 kΩ	2.75
5.4	11.2 kΩ	3.54	14.3 kΩ	2.7
5.3	21.6 kΩ	3.48	25.7 kΩ	2.65
5.2	42.4 kΩ	3.42	48.6 kΩ	2.6
5.1	105.0 kΩ	3.36	117.0 kΩ	2.55
5.0		3.3		2.5
4.9	(99.8) kΩ	3.24	(112.0) kΩ	2.45
4.8	(37.4) kΩ	3.18	(43.6) kΩ	2.4
4.7	(16.6) kΩ	3.12	(20.8) kΩ	2.35
4.6	(6.2) kΩ	3.06	(9.3) kΩ	2.3
4.5	(0.0)	3.0	(2.5) kΩ	2.25

R₁ = (Blue), R₂ = Black

Table 3-2b; ADJUSTMENT RESISTOR VALUES, Vo₂

24 V Bus Pt.#	PT4681	PT4682	PT4683/6/7	PT4686	PT4685	
48 V Bus Pt.#	PT4661	PT4662	PT4663/6/7	PT4666	PT4665	PT4668
Adj. Resistor	(R3)/R4	(R3)/R4	(R3)/R4	(R3)/R4	(R3)/R4	(R3)/R4
V _o (nom)	3.3 V	2.5 V	1.8 V	1.8 V	1.5 V	1.2 V
V _a (req'd)	V _a (req'd)		V _a (req'd)			
3.6	1.7 kΩ		1.95	2.3 kΩ	3.9 kΩ	
3.54	3.3 kΩ		1.9	5.9 kΩ	7.6 kΩ	
3.48	6.1 kΩ		1.85	16.8 kΩ	18.5 kΩ	
3.42	11.6 kΩ		1.8			
3.36	28.3 kΩ		1.75	(15.6) kΩ	(17.3) kΩ	
3.3			1.7	(4.7) kΩ	(6.4) kΩ	
3.24	(27.1) kΩ		1.65	(1.1) kΩ	(2.7) kΩ	1.1 kΩ
3.18	(10.4) kΩ		1.6			4.1 kΩ
3.12	(4.9) kΩ		1.55			13.2 kΩ
3.06	(2.1) kΩ		1.5			
3.0	(0.5) kΩ		1.45		(12.0) kΩ	
2.75		1.1 kΩ	1.4		(2.9) kΩ	
2.7		2.6 kΩ	1.35		(0.0) kΩ	
2.65		5.1 kΩ	1.3			3.9 kΩ
2.6		10.1 kΩ	1.275			6.4 kΩ
2.55		25.3 kΩ	1.25			11.2 kΩ
2.5			1.225			25.7 kΩ
2.45		(24.1) kΩ	1.2			
2.4		(8.9) kΩ	1.175			(24.5) kΩ
2.35		(3.9) kΩ	1.15			(10.0) kΩ
2.3		(1.4) kΩ	1.125			(5.2) kΩ
2.25		(0.0)kΩ	1.1			(2.7) kΩ

R₃ = (Blue), R₄ = Black

PACKAGING INFORMATION

Orderable Device	Status ⁽¹⁾	Package Type	Package Drawing	Pins	Package Qty	Eco Plan ⁽²⁾	Lead/Ball Finish	MSL Peak Temp ⁽³⁾
PT4661A	ACTIVE	SIP MOD ULE	EKA	26	6	TBD	Call TI	Level-1-215C-UNLIM
PT4661C	ACTIVE	SIP MOD ULE	EKC	26	6	TBD	Call TI	Level-3-215C-168HRS
PT4661N	ACTIVE	SIP MOD ULE	EKD	26	6	TBD	Call TI	Level-1-215C-UNLIM
PT4662A	ACTIVE	SIP MOD ULE	EKA	26	6	TBD	Call TI	Level-1-215C-UNLIM
PT4662C	ACTIVE	SIP MOD ULE	EKC	26	6	TBD	Call TI	Level-3-215C-168HRS
PT4662N	ACTIVE	SIP MOD ULE	EKD	26	6	TBD	Call TI	Level-1-215C-UNLIM
PT4663A	ACTIVE	SIP MOD ULE	EKA	26	6	TBD	Call TI	Level-1-215C-UNLIM
PT4663C	ACTIVE	SIP MOD ULE	EKC	26	6	TBD	Call TI	Level-3-215C-168HRS
PT4663N	ACTIVE	SIP MOD ULE	EKD	26	6	TBD	Call TI	Level-1-215C-UNLIM
PT4665A	ACTIVE	SIP MOD ULE	EKA	26	6	TBD	Call TI	Level-1-215C-UNLIM
PT4665C	ACTIVE	SIP MOD ULE	EKC	26	6	TBD	Call TI	Level-3-215C-168HRS
PT4665N	ACTIVE	SIP MOD ULE	EKD	26	6	TBD	Call TI	Level-1-215C-UNLIM
PT4666A	ACTIVE	SIP MOD ULE	EKA	26	6	TBD	Call TI	Level-1-215C-UNLIM
PT4666C	ACTIVE	SIP MOD ULE	EKC	26	6	TBD	Call TI	Level-3-215C-168HRS
PT4666N	ACTIVE	SIP MOD ULE	EKD	26	6	TBD	Call TI	Level-1-215C-UNLIM
PT4667A	ACTIVE	SIP MOD ULE	EKA	26	6	TBD	Call TI	Level-1-215C-UNLIM
PT4667C	ACTIVE	SIP MOD ULE	EKC	26	6	TBD	Call TI	Level-3-215C-168HRS
PT4667N	ACTIVE	SIP MOD ULE	EKD	26	6	TBD	Call TI	Level-1-215C-UNLIM
PT4668A	ACTIVE	SIP MOD ULE	EKA	26	6	TBD	Call TI	Level-1-215C-UNLIM
PT4668C	ACTIVE	SIP MOD ULE	EKC	26	6	TBD	Call TI	Level-3-215C-168HRS
PT4668N	ACTIVE	SIP MOD ULE	EKD	26	6	TBD	Call TI	Level-1-215C-UNLIM

⁽¹⁾ The marketing status values are defined as follows:

ACTIVE: Product device recommended for new designs.

LIFEBUY: TI has announced that the device will be discontinued, and a lifetime-buy period is in effect.

NRND: Not recommended for new designs. Device is in production to support existing customers, but TI does not recommend using this part in a new design.

PREVIEW: Device has been announced but is not in production. Samples may or may not be available.

OBSELETE: TI has discontinued the production of the device.

(2) Eco Plan - The planned eco-friendly classification: Pb-Free (RoHS) or Green (RoHS & no Sb/Br) - please check <http://www.ti.com/productcontent> for the latest availability information and additional product content details.

TBD: The Pb-Free/Green conversion plan has not been defined.

Pb-Free (RoHS): TI's terms "Lead-Free" or "Pb-Free" mean semiconductor products that are compatible with the current RoHS requirements for all 6 substances, including the requirement that lead not exceed 0.1% by weight in homogeneous materials. Where designed to be soldered at high temperatures, TI Pb-Free products are suitable for use in specified lead-free processes.

Green (RoHS & no Sb/Br): TI defines "Green" to mean Pb-Free (RoHS compatible), and free of Bromine (Br) and Antimony (Sb) based flame retardants (Br or Sb do not exceed 0.1% by weight in homogeneous material)

(3) MSL, Peak Temp. -- The Moisture Sensitivity Level rating according to the JEDEC industry standard classifications, and peak solder temperature.

Important Information and Disclaimer:The information provided on this page represents TI's knowledge and belief as of the date that it is provided. TI bases its knowledge and belief on information provided by third parties, and makes no representation or warranty as to the accuracy of such information. Efforts are underway to better integrate information from third parties. TI has taken and continues to take reasonable steps to provide representative and accurate information but may not have conducted destructive testing or chemical analysis on incoming materials and chemicals. TI and TI suppliers consider certain information to be proprietary, and thus CAS numbers and other limited information may not be available for release.

In no event shall TI's liability arising out of such information exceed the total purchase price of the TI part(s) at issue in this document sold by TI to Customer on an annual basis.

IMPORTANT NOTICE

Texas Instruments Incorporated and its subsidiaries (TI) reserve the right to make corrections, modifications, enhancements, improvements, and other changes to its products and services at any time and to discontinue any product or service without notice. Customers should obtain the latest relevant information before placing orders and should verify that such information is current and complete. All products are sold subject to TI's terms and conditions of sale supplied at the time of order acknowledgment.

TI warrants performance of its hardware products to the specifications applicable at the time of sale in accordance with TI's standard warranty. Testing and other quality control techniques are used to the extent TI deems necessary to support this warranty. Except where mandated by government requirements, testing of all parameters of each product is not necessarily performed.

TI assumes no liability for applications assistance or customer product design. Customers are responsible for their products and applications using TI components. To minimize the risks associated with customer products and applications, customers should provide adequate design and operating safeguards.

TI does not warrant or represent that any license, either express or implied, is granted under any TI patent right, copyright, mask work right, or other TI intellectual property right relating to any combination, machine, or process in which TI products or services are used. Information published by TI regarding third-party products or services does not constitute a license from TI to use such products or services or a warranty or endorsement thereof. Use of such information may require a license from a third party under the patents or other intellectual property of the third party, or a license from TI under the patents or other intellectual property of TI.

Reproduction of information in TI data books or data sheets is permissible only if reproduction is without alteration and is accompanied by all associated warranties, conditions, limitations, and notices. Reproduction of this information with alteration is an unfair and deceptive business practice. TI is not responsible or liable for such altered documentation.

Resale of TI products or services with statements different from or beyond the parameters stated by TI for that product or service voids all express and any implied warranties for the associated TI product or service and is an unfair and deceptive business practice. TI is not responsible or liable for any such statements.

Following are URLs where you can obtain information on other Texas Instruments products and application solutions:

Products		Applications	
Amplifiers	amplifier.ti.com	Audio	www.ti.com/audio
Data Converters	dataconverter.ti.com	Automotive	www.ti.com/automotive
DSP	dsp.ti.com	Broadband	www.ti.com/broadband
Interface	interface.ti.com	Digital Control	www.ti.com/digitalcontrol
Logic	logic.ti.com	Military	www.ti.com/military
Power Mgmt	power.ti.com	Optical Networking	www.ti.com/opticalnetwork
Microcontrollers	microcontroller.ti.com	Security	www.ti.com/security
		Telephony	www.ti.com/telephony
		Video & Imaging	www.ti.com/video
		Wireless	www.ti.com/wireless

Mailing Address: Texas Instruments
Post Office Box 655303 Dallas, Texas 75265